

WORKING TOGETHER



**sunnex**<sup>®</sup>



**TASK LIGHTING CATALOG**

For over 30 years, **Sunnex** has manufactured lighting products that set the standard for quality and durability. Developed with ergonomics and flexibility in mind, **Sunnex** lights are specifically designed for ease of use and years of dependable operation. Our quality construction is backed by a three year warranty on performance and parts, and we offer a lifetime customer support guarantee. Whatever the application, **Sunnex** lighting systems can help illuminate the task at hand – bringing light to the focus of your work and surroundings.

**Sunnex** lighting is available in a wide variety of models and configurations. We offer compact models ideal for lighting small spaces; rugged, moisture proof models for harsh industrial environments; magnifying lights for detailed assembly and inspection; and specialty reflectors and bulbs for heat-sensitive applications. In addition, **Sunnex** lights are available with either gooseneck or articulating arms; table, wall, c-clamp and direct mounting configurations, and various other options.

All of our lighting products are designed to meet the highest of international standards including UL, CE and CAN/CSA listings. In addition, **Sunnex** is an ISO 9001:2000 registered company. The Company has sales and service representatives located in over 40 countries worldwide with the American facility located in Natick, Massachusetts, and European headquarters located in Stockholm, Sweden. For additional information, visit our global web site at [www.sunnex.com](http://www.sunnex.com).

### Sunnex Equipment AB - Sweden



Sunnex Inc. - USA



Sunnex GmbH - Germany



Sunnex Equipment Sarl - France



|                                                                                 |                              |
|---------------------------------------------------------------------------------|------------------------------|
| <b>Halogen 20W - HT Series Lighting</b>                                         | <b>Page 2</b>                |
| HT200 & HT300 .....                                                             | 2                            |
| HT Applications & Mounting Options .....                                        | 3                            |
| <br><b>Halogen 20W - HS Series Lighting</b>                                     | <br><b>Page 4</b>            |
| HS700 & HS Options .....                                                        | 4                            |
| HS710 & HS Accessories .....                                                    | 5                            |
| HS740 & HS Base Configurations .....                                            | 6                            |
| HS Applications & Mounting Options .....                                        | 7                            |
| <br><b>Halogen 35W - HM Series Lighting</b>                                     | <br><b>Page 8</b>            |
| HM1000 .....                                                                    | 8                            |
| HM1010 & HM Accessories .....                                                   | 9                            |
| HM1100 & HM Base Configurations .....                                           | 10                           |
| HM Applications & Mounting Options .....                                        | 11                           |
| <br><b>Halogen 50/75W - HF Series Lighting</b>                                  | <br><b>Page 12</b>           |
| HF2000 .....                                                                    | 12                           |
| HF2010 & HF Accessories .....                                                   | 13                           |
| HF2100 & HF Base Configurations .....                                           | 14                           |
| HF Applications & Mounting Options .....                                        | 15                           |
| <br><b>Halogen &amp; Fluorescent - Illuminated Magnifiers &amp; Work Lights</b> | <br><b>Page 16</b>           |
| HS Series & RLM Series .....                                                    | 16                           |
| CLB Series & CLM Series .....                                                   | 17                           |
| <br><b>Halogen 20/35/50 &amp; 75W - Spot Lights</b>                             | <br><b>Page 18</b>           |
| HS Series .....                                                                 | 18                           |
| HT Series, HM Series & HF Series .....                                          | 19                           |
| <br><b>Fluorescent Task Lighting</b>                                            | <br><b>Page 20</b>           |
| CL Series & Mounting Options .....                                              | 20                           |
| <br><b>Custom Lighting Solutions</b>                                            | <br><b>Inside Back Cover</b> |

The compact design of this 20W halogen light combined with its flexible gooseneck, makes it ideal for applications with small or hard-to-reach work areas.

Features include:

- Versatile, focused light with compact lamp head
- Swivel joint for added maneuverability
- Flexible gooseneck arm for easy light positioning

### HT300 - Flexible Gooseneck Light

|                      | Standard              | Optional                            |
|----------------------|-----------------------|-------------------------------------|
| Power Supply         | 120V                  | 230V (Euro plug)                    |
| Arm Length           | 20"                   | -                                   |
| Lamp Head            | Swivel joint          | -                                   |
| Lens/Filter          | Frosted               | Clear                               |
| Base                 | Direct                | Magnetic, C-Clamp, Table, L-bracket |
| Switch               | Rocker switch on base | Button switch on head               |
| Dimmer               | No                    | -                                   |
| Cord                 | 7' SJT                | -                                   |
| Safety Class (Int'l) | IP20                  | -                                   |
| Color                | Matte black           | Off-white                           |

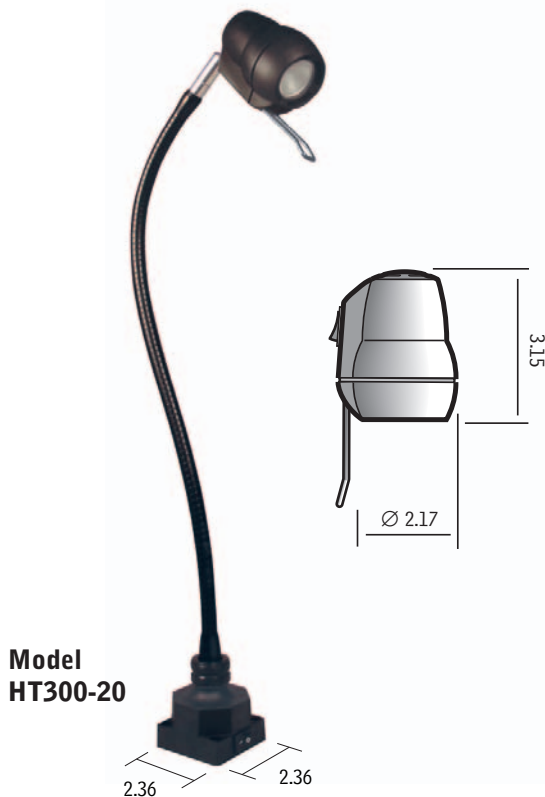

Model  
HT300-20

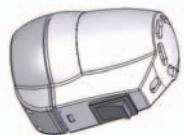

**Switch on Head** (-HS) For convenient on/off control, a push button switch can be mounted on the back of the lamphead.

### HT200 Low Voltage Flexible Gooseneck Light

|                      | Standard              | Optional              |
|----------------------|-----------------------|-----------------------|
| Power supply         | 12V                   | 24V                   |
| Arm Length           | 20                    | -                     |
| Lamp Head            | Swivel joint          | -                     |
| Lens/Filter          | Frosted               | Clear                 |
| Base                 | Direct                | -                     |
| Switch               | Rocker switch on base | Button switch on head |
| Dimmer               | No                    | Yes                   |
| Cord                 | 7' SVT P302 plug      | -                     |
| Safety Class (Int'l) | IP20                  | -                     |
| Color                | Matte black           | Off-white             |



Model  
HT200-20W

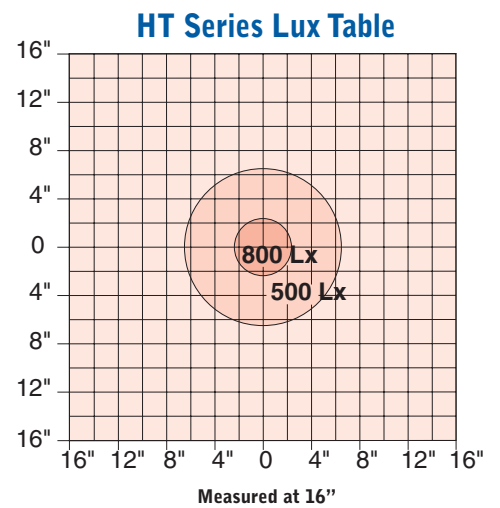

Ideal for applications including:

- Microscope Illumination
- Assembly and Inspection Areas
- Workstations
- Office Areas



### HT Series Mounting Options



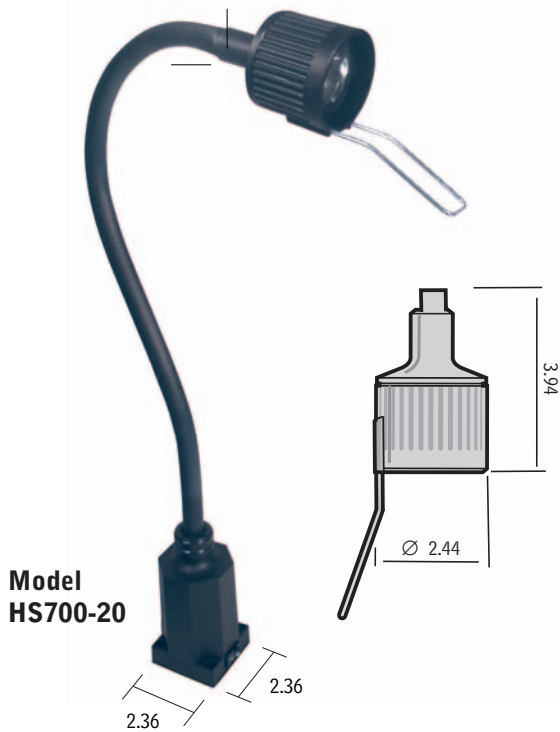

The HS Series of lights are designed for ease-of-use and engineered to withstand heavy production schedules. The compact head, made of high impact polyamide plastic, allows for unobstructed views of the work area.

Features include:

- Flexible gooseneck or heavy duty articulating arm ideal for small or hard to reach work areas
- Scratch resistant PUR-sleeving protects gooseneck from dust, oils, and moisture
- High intensity 20W halogen bulb offers more than 2,000 hours of projected light
- Available in variety of arm lengths and mounting configurations

\*IP65 version available on low voltage models

### HS700 - Flexible Gooseneck Light

|                      | Standard              | Optional                                      |
|----------------------|-----------------------|-----------------------------------------------|
| Power Supply         | 120V                  | 230V (Euro plug)                              |
| Arm Length           | 20"                   | 12", 27"                                      |
| Lamp Head            | Straight neck         | Swivel Joint, Quick Detach, Fixed Right Angle |
| Lens/Filter          | Clear                 | Frosted, Red, UV, Blue                        |
| Base                 | Direct                | Magnetic, C-Clamp, Table, L-bracket           |
| Switch               | Rocker switch on base | Button switch on head                         |
| Dimmer               | No                    | No                                            |
| Cord                 | 7' SJT                | -                                             |
| Safety Class (Int'l) | IP20                  | -                                             |
| Color                | Matte black           | Off-white                                     |

### HS 700 Series Options



#### Right Angle Head

(-RA) eliminates the need for too sharp a bend of the gooseneck and extends reach.



#### Right Angle/Swivel Joint Lamphead

(-SJ) provides 360° axial rotation and 90° angular adjustment.



#### Quick-detach Lamphead

(-QD) permits hand-held use for temporary illumination of hard to reach areas. Coiled cord stretches about 40".

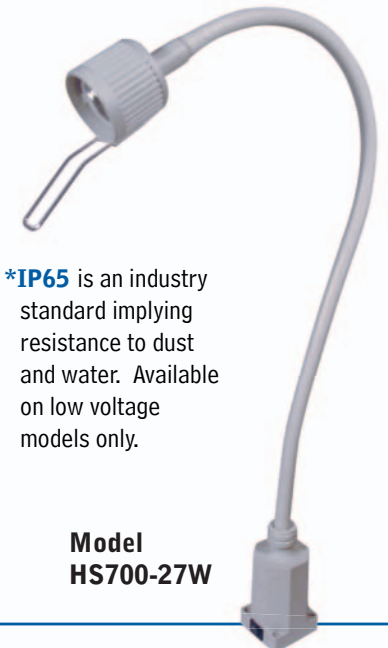

\*IP65 is an industry standard implying resistance to dust and water. Available on low voltage models only.

Model  
HS700-27W



## HS710 AAS Heavy Duty (HD) Light

|                      | Standard                         | Optional                        |
|----------------------|----------------------------------|---------------------------------|
| Power supply         | 110V (plug in ransformer)        | 230V (plug in transformer Euro) |
| Arm Length           | 39" two-section                  | 49" three-section               |
| Lamp Head            | Swivel joint                     | -                               |
| Lens/Filter          | Clear                            | Frosted, Red, UV, Blue          |
| Base                 | Direct mount                     | C-Clamp                         |
| Switch               | Button switch on head            | -                               |
| Dimmer               | No                               | No                              |
| Cord                 | 7' cord - plug in transformer    | -                               |
| Safety Class (Int'l) | IP20                             | -                               |
| Color                | Nickel plated steel-black joints | -                               |

The HS710 AAS model comes standard with a heavy duty articulating arm that offers extensive reach. This unique arm system keeps the lamp in position - even in the most demanding environments.

Features include:

- Rugged 39"(1000mm) or 49"(1250mm) steel articulating arm for extensive reach
- Adjustable joints for easy positioning
- Heavy-duty, vibration resistant arm ideal for demanding environments

Model  
HS710-49

Model  
HS710-39

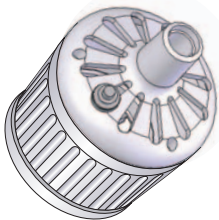

**Switch on Head (-HS)** For convenient on/off control, a push button switch can be mounted on the back of the lamphead.

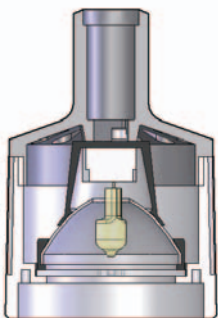

**Moisture/Dust Resistant Head (-MR)** Two silicone seals prevent accumulation of dust, dirt and moisture inside the reflector and on the light bulb (not available for Right Angle/Swivel Joint Lamphead and Dichroic Reflector Lamps).

## HS Series Accessories



**Lenses/Filters** include clear, frosted and red lenses; UV and blue filters.



**Bulbs** supplied are 12V/20W halogen. Optional 12V/20W Dichroic Lamps dissipate 60% of heat through back of lamp thus reducing the amount of heat projected forward.



**Model  
HS741-20**

### HS740 Low Voltage Flexible Gooseneck Light

|                      | Standard                      | Optional                                      |
|----------------------|-------------------------------|-----------------------------------------------|
| Power supply         | 12V                           | 24V                                           |
| Arm Length           | 20"                           | 12", 27"                                      |
| Lamp Head            | Straight neck                 | Swivel Joint, Quick Detach, Fixed Right Angle |
| Lens/Filter          | Clear                         | Frosted, Red, UV, Blue                        |
| Base                 | Square (HS741)                | Rectangular, Panel, Plug-in                   |
| Switch               | Rocker switch on base         | Button switch on head                         |
| Dimmer               | No                            | Yes (HS741 only)                              |
| Cord                 | 7' SVT P302 plug (HS741, 742) | 6" lead wires (HS747)                         |
| Safety Class (Int'l) | IP20                          | IP65                                          |
| Color                | Matte-black                   | Off-white                                     |

These safe, low voltage lights are ideal for industrial machinery, emergency vehicles, medical equipment, and marine applications. Offered in a variety of configurations, this light is the perfect solution for all types of equipment manufacturers.

Features include:

- Safe, low voltage 12V operation (also available in 24V option)
- Rugged, stay-put PUR-sleeved gooseneck
- Compact lamp head ideal for small spaces
- Remote transformer available
- Available with LED bulb option



#### Transformers Model 410

120V/12V, 25VA, all steel design, zinc plated enclosure, circuit breaker protection, S302 Cinch-Jones socket for P302 lamp cord plug recommended for models 741 and 742.

#### Model 710-05B

transformer core/coil, 25VA with mounting brackets. For installation in an enclosure.

#### Electronic 12V/24V Dimmer

(-ED) available for lamps with the square sub-base (Model 741), must be used with Model 610 transformer or 35VA power supply.

### HS 740 Base Configurations



**Plug-in**



**Square**



**Rectangular**



**Panel**





**HS Series Lux Table**

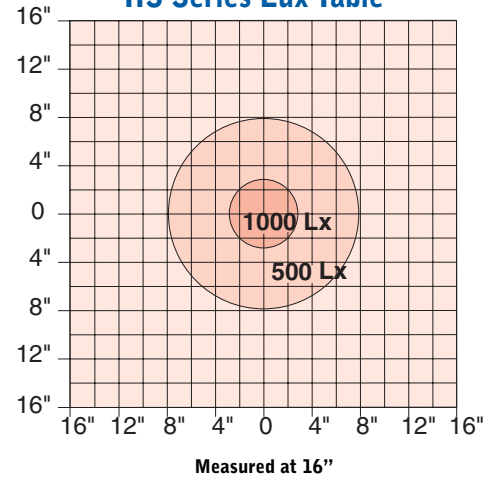

**Ideal for applications including:**

- Industrial Machinery
- Emergency Vehicles
- Marine
- Medical Equipment
- Assembly and Inspection Areas



**HS Series Mounting Options**



This unique "Cool Touch" light is available in 3 different configurations including flexible gooseneck, long-reach heavy duty articulating arm and spot light. The HM series comes with either an integrated transformer for 120V/230V or in a low-voltage version for direct connection to machinery. A spot reflector and frosted lens are standard. Certain models can be supplied with a dimmer, and a 12V/35W long-life halogen light bulb is included.

Features include:

- Unique vented lamp shade provides low surface temperature for easy handling
- Swivel joint allows for precise light positioning
- Intense 35W halogen bulb offers bright, white light
- Available in flexible gooseneck or articulating arm
- PUR-Sleeving protects gooseneck arm from dust, oils and moisture.

**Model  
HM1000-20**

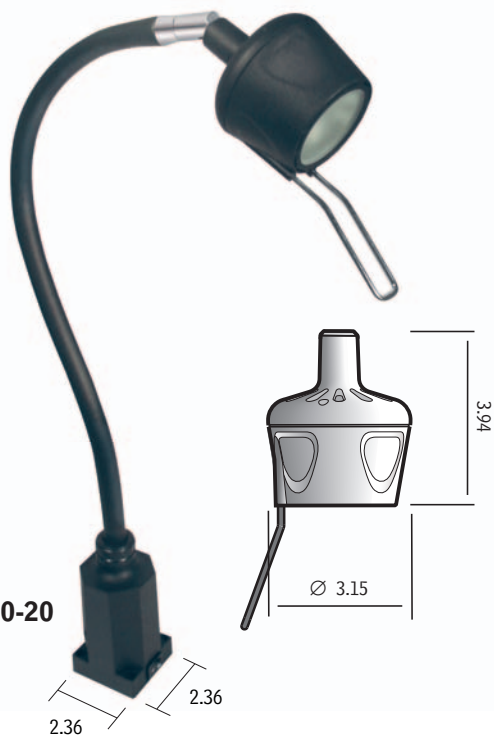

### HM1000 - Flexible Gooseneck Light

|                      | Standard              | Optional                            |
|----------------------|-----------------------|-------------------------------------|
| Power Supply         | 120V                  | 230V (Euro plug)                    |
| Arm Length           | 20"                   | 12", 27"                            |
| Lamp Head            | Swivel joint          | Straight neck                       |
| Lens/Filter          | Frosted               | Clear                               |
| Base                 | Direct                | Magnetic, C-Clamp, Table, L-bracket |
| Switch               | Rocker switch on base | Button switch on head               |
| Dimmer               | No                    | Yes                                 |
| Cord                 | 7' SJT                | -                                   |
| Safety Class (Int'l) | IP20                  | -                                   |
| Color                | Matte black           | Off-white                           |



**Switch on Head** (-HS) For convenient on/off control, a push button switch can be mounted on the back of the lamphead.



**Model  
HM1000-27W**



## HM1010 AAS Heavy Duty (HD) Light

|                      | Standard                         | Optional                        |
|----------------------|----------------------------------|---------------------------------|
| Power supply         | 120V (plug in transformer)       | 230V (plug in transformer Euro) |
| Arm Length           | 39" two-section                  | 49" three-section               |
| Lamp Head            | Swivel joint                     | -                               |
| Lens/Filter          | Frosted                          | Clear                           |
| Base                 | Universal mount                  | C-Clamp                         |
| Switch               | Button switch on head            | -                               |
| Dimmer               | No                               | No                              |
| Cord                 | 7' cord - plug in transformer    | -                               |
| Safety Class (Int'l) | IP20                             | -                               |
| Color                | Nickel plated steel-black joints | -                               |

The HM1010 AAS model comes standard with a heavy duty articulating arm that offers extensive reach. This unique arm system keeps the lamp in position - even in the most demanding environments.

Features include:

- Rugged 39"(1000mm) or 49"(1250mm) steel articulating arm offers extensive reach
- Adjustable joints for easy positioning
- Heavy-duty, vibration resistant arm ideal for harsh environments

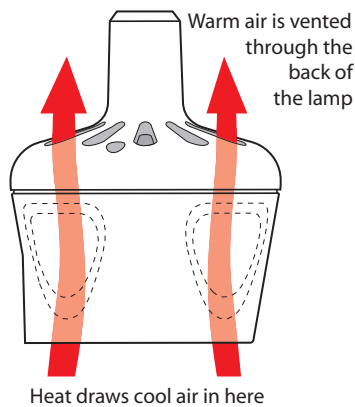

## HM Series Accessories

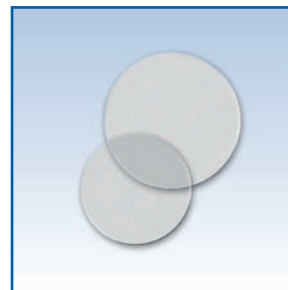

**Lenses/Filters** includes clear or frosted lenses.



**Bulbs** supplied are 12V/35W halogen. Optional 12V/35W Dichroic Lamps dissipate 60% of heat through back of lamp thus reducing the amount of heat projected forward.



**Model  
HM1100-20**

### HM1100 Flexible Gooseneck Light

|                      | Standard              | Optional               |
|----------------------|-----------------------|------------------------|
| Power supply         | 12V                   | 24V                    |
| Arm Length           | 20"                   | 12", 27"               |
| Lamp Head            | Swivel joint          | Straight neck          |
| Lens/Filter          | Frosted               | Clear                  |
| Base                 | Square (HM1100)       | Rectangular, Panel     |
| Switch               | Rocker switch on base | Button switch on head  |
| Dimmer               | No                    | Yes (HM1100 only)      |
| Cord                 | 7' SVT P302 plug      | 6" lead wires (HM1147) |
| Safety Class (Int'l) | IP20                  | -                      |
| Color                | Matte black           | Off-white              |

These safe, low voltage lights are ideal for industrial machinery, emergency vehicles, medical equipment, and marine applications. Offered in a variety of configurations, this light is the perfect solution for all types of equipment manufacturers.

Features include:

- Safe, low voltage 12V operation (also available in 24V option)
- Rugged, stay-put flexible gooseneck
- Compact lamp head ideal for small spaces
- Remote transformer available
- Available with LED bulb option

### HM1100 Base Configurations



**Square**



**Rectangular**



**Panel**



### Transformers Model 610

120V/12V, 75VA, all steel design, zinc plated enclosure, circuit breaker protection, S302 Cinch-Jones socket for P302 lamp cord plug. 7' SJT cord with grounded plug. For use with low voltage lamps.

### Model 610-05B

Transformer core/coil 120V/12V, 75VA with mounting brackets. For installation in an enclosure.

### Electronic 12V/24V Dimmer

(-ED) available for lamps with the square sub-base (Model 1100), must be used with Model 610 transformer or 35VA power supply.

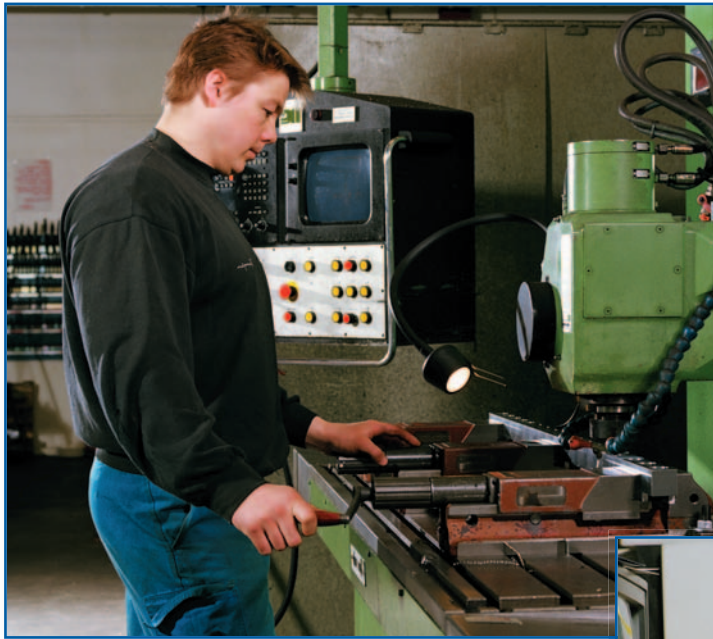

**HM Series Lux Table**

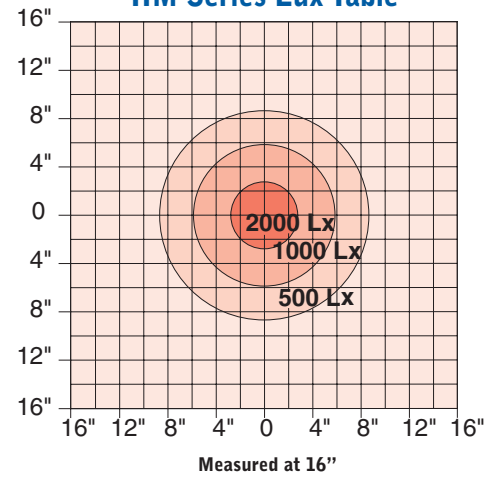

**Ideal for applications including:**

- **Light Assembly**
- **Detail Inspection Areas**
- **Medical Equipment**



**HM Series Mounting Options**



**Model  
HF2000-20**

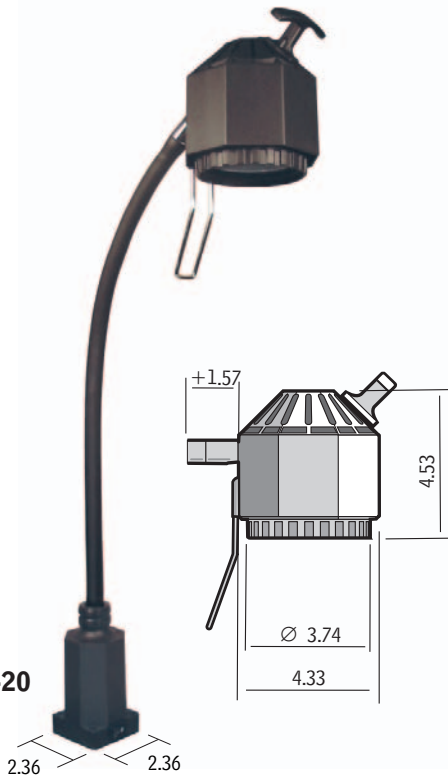

The HF Series is designed to withstand heavy production schedules. This high intensity work light is available in 3 different configurations including a flexible gooseneck, long-reach heavy duty articulating arm and spot light. The HF series is offered with either an integrated transformer for 120V/230V or in a low-voltage version for direct connection to machinery. A spot reflector and clear lens are standard. A 12V/50W long-life halogen light bulb is included.

Features include:

- Moisture-resistant design for harsh environments
- Flexible gooseneck or heavy-duty articulating arm resists heavy vibration
- Powerful 50W halogen bulb provides bright, white light (75W bulb optional)
- Swivel joint allows for easy light positioning
- Designed with high impact polyamide plastic which stays virtually scratch-free

\*IP65 version available on low voltage models

### HF2000 - Flexible Gooseneck Light

|                      | Standard              | Optional                            |
|----------------------|-----------------------|-------------------------------------|
| Power Supply         | 120V                  | 230V (Euro plug)                    |
| Arm Length           | 20"                   | 12", 27"                            |
| Lamp Head            | Swivel joint          | Straight neck                       |
| Lens/Filter          | Clear                 | Frosted                             |
| Base                 | Direct                | Magnetic, C-Clamp, Table, L-bracket |
| Switch               | Rocker switch on base | Toggle switch on head               |
| Dimmer               | No                    | No                                  |
| Cord                 | 7' SJT                | -                                   |
| Safety Class (Int'l) | IP20                  | -                                   |
| Color                | Matte black           | Off-white                           |

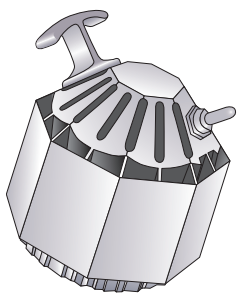

#### Switch on Head (-HS)

For convenient on/off control, a switch is mounted on the back of the lamphead.



\*IP65 is an industry standard implying resistance to dust and water.

**Model  
HF2000-27W**



## HF2010 AAS Heavy Duty (HD) Light

|                      | Standard                            | Optional                        |
|----------------------|-------------------------------------|---------------------------------|
| Power supply         | 120V (plug in transformer)          | 230V (plug in transformer Euro) |
| Arm Length           | 39" two-section                     | 49" three-section               |
| Lamp Head            | Swivel joint                        | -                               |
| Lens/Filter          | Clear                               | Frosted                         |
| Base                 | Universal mount                     | C-Clamp                         |
| Switch               | Toggle switch on head               | -                               |
| Dimmer               | No                                  | No                              |
| Cord                 | 7' cord - plug in transformer       | -                               |
| Safety Class (Int'l) | IP20                                | -                               |
| Color                | Nickel plated steel<br>black joints | -                               |

The HF2010 AAS model comes standard with a heavy duty articulating arm that offers extensive reach. This unique arm system keeps the lamp in position - even in the harshest environments.

Features include:

- Rugged 39" (1000mm) or 49" (1250mm) steel articulating arm for extensive reach
- Adjustable joints for easy positioning
- Heavy-duty, vibration resistant arm ideal for the most demanding environments
- Designed with high impact polyamide plastic which stays virtually scratch-free

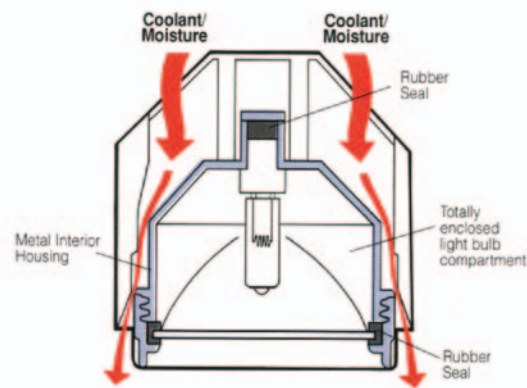

**Moisture-proof lens/reflector/lamp compartment** is totally enclosed by a metal interior housing and rubber seals making the lamps ideal for even the harshest applications.

## HF Series Accessories

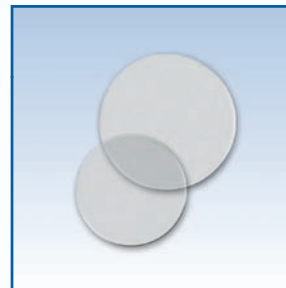

**Lenses/Filters** include clear or frosted lenses.



**Bulbs** supplied are 12V/50W/75W halogen. Optional 12V/50W/75W Dichroic Lamps dissipate 60% of heat through back of lamp thus reducing the amount of heat projected forward.



## HF2100 Low Voltage Flexible Gooseneck Light

|                      | Standard              | Optional              |
|----------------------|-----------------------|-----------------------|
| Power supply         | 12V                   | 24V                   |
| Arm Length           | 20"                   | 12", 27"              |
| Lamp Head            | Swivel joint          | -                     |
| Lens/Filter          | Clear                 | Frosted               |
| Base                 | Square                | Rectangular, Panel    |
| Switch               | Rocker switch on base | Toggle switch on head |
| Dimmer               | No                    | No                    |
| Cord                 | 7' SVT P302 plug      | 6" lead wires         |
| Safety Class (Int'l) | IP20                  | IP65                  |
| Color                | Matte Black           | Off-white             |



### Features include:

- Powerful 50W halogen bulb provides bright, white light (75W bulb optional)
- Moisture-resistant design for harsh environments
- Rugged PUR-sleeved gooseneck
- Remote transformer option available
- IP65 version available

### Transformers Model 610

120V/12V, 75VA, all steel design, zinc plated enclosure, circuit breaker protection, S302 Cinch-Jones socket for P302 lamp cord plug. 7' SJT cord with grounded plug. For use with low voltage lamps.

### Model 610-05B

Transformer core/coil 120V/12V, 75VA with mounting brackets. For installation in an enclosure.

## HF 2100 Base Configurations



Square



Rectangular

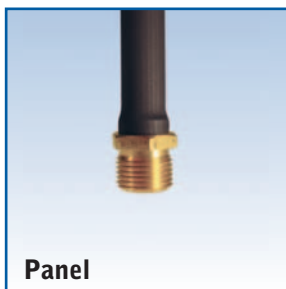

Panel



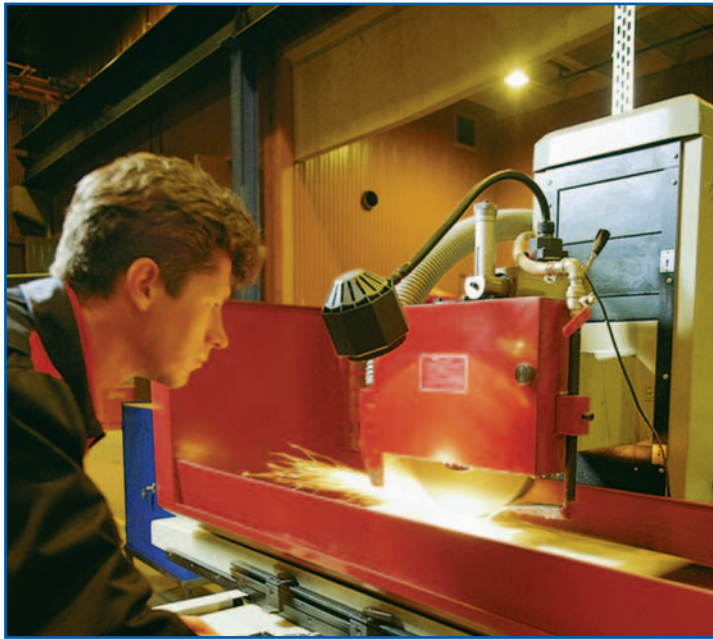

**HF Series Lux Table 50W**

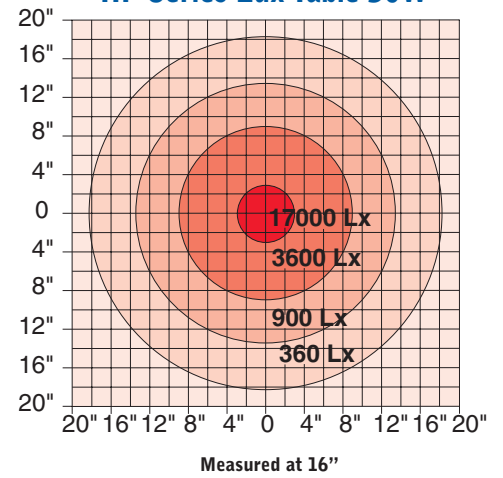

**Ideal for applications including:**

- Industrial Machinery
- Assembly and Inspection Areas
- Machine Tools



**HF Series Lux Table 75W**

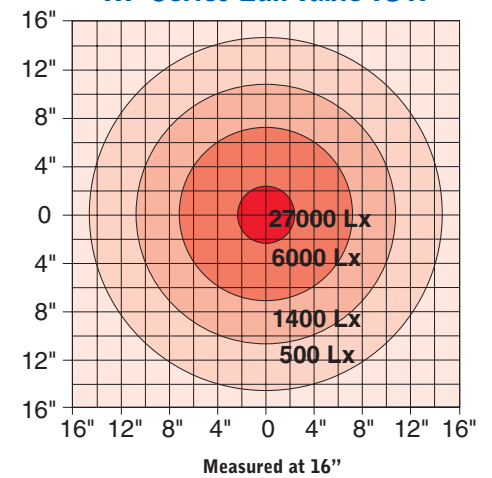

**HF Series Mounting Options**

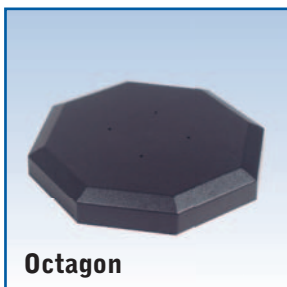



## HS704-27MS - Illuminated Halogen Magnifier

This magnifying lamp is based on our popular 700 Series of 20W lamps with an added feature, the gooseneck magnifier.

Features include:

- Intense 20W halogen bulb
- Flexible 27" gooseneck arm for easy light positioning
- Magnifier on additional 20" gooseneck arm for easy adjustment
- Distortion free lens with 2X magnification (4 diopter)

|                      | Standard              | Optional                                      |
|----------------------|-----------------------|-----------------------------------------------|
| Power supply         | 120V                  | 230V (Euro plug)                              |
| Arm Length           | 27" lamp - 20" lens   | -                                             |
| Lamp Head            | Straight neck         | Swivel Joint, Quick Detach, Fixed Right Angle |
| Lens/Filter          | Clear                 | Frosted, Red, UV, Blue                        |
| Base                 | Table                 | C-Clamp                                       |
| Switch               | Rocker switch on base | Button switch on head                         |
| Dimmer               | No                    | No                                            |
| Cord                 | 7' SJT                | -                                             |
| Safety Class (Int'l) | IP20                  | -                                             |
| Color                | Matte black           | Off-white                                     |

Model  
HS704-27MS



**Magnifier Attachment**  
for 700 Series also available

## RLM Series - Illuminated Fluorescent Magnifier

The RLM Series of magnifying lights offers superior light intensity for detailed inspection.

Features include:

- Magnification of 2.25X (5 diopter)
- 22W fluorescent ring light with low heat emission
- Optional 2.25X add-on lens available

|              | Standard           | Optional         |
|--------------|--------------------|------------------|
| Power Supply | 120V               | 230V (Euro plug) |
| Arm Length   | 32"                | -                |
| Base         | C-clamp            | Trolley base     |
| Switch       | Rocker switch head | -                |
| Cord         | 6'                 | -                |
| Color        | Off white          | -                |



RLM Series Magnifier

### CLB Series Work Lights

The CLB Series of work lights is ideal for workbench applications. This flicker-free fluorescent light is easy to adjust and is equipped with spring-loaded joints that ensure the lamp stays exactly where it is needed. Optional C-clamp mounting available.

Features include:

- Bright, powerful daylight quality illumination
- Adjustable lamp head for easy light positioning
- Total arm length of 44 inches
- Choice of different power configurations including 2 x 18, 2 x 36, or 1 x 36 watts

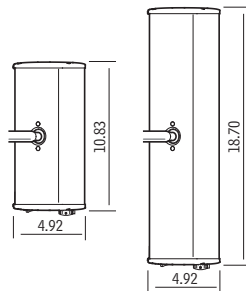

CLB Series

### CLB Series Lux Tables

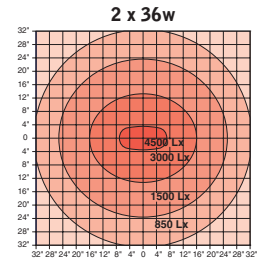
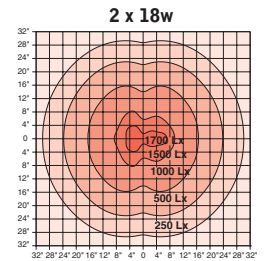
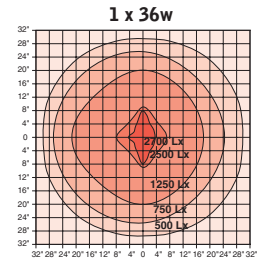

All Measured at 16"



CLM Series

### CLM Series Magnifying Lights

The CLM Series is a high quality magnifying light that offers superior illumination backed by solid construction. The CLM is easy to adjust offering an ergonomic handle and individually adjustable magnifying lens. In addition, the unit offers distortion-free magnification and is equipped with a fluorescent flicker-free light source. Optional C-clamp mounting available.

Features include:

- Easily adjustable magnifying lens
- Distortion-free magnification at 1.75X
- Total arm length of 44 inches
- Choice of different power configurations including 2 x 18, 2 x 36, or 1 x 36 watts



### CLM Series Lux Tables

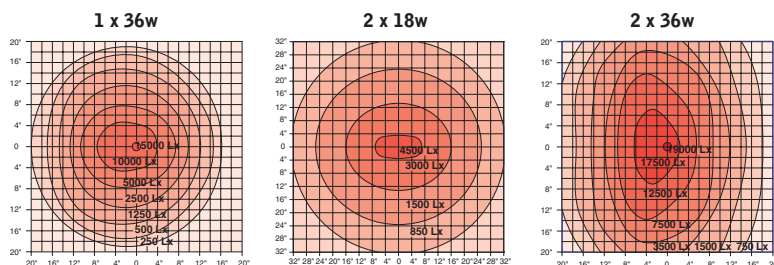

All Measured at 16"

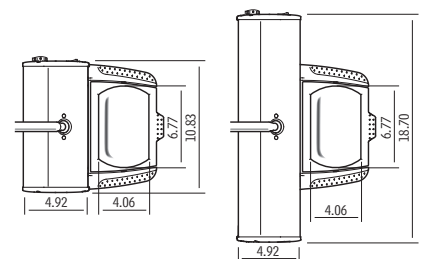



**Model  
HS761-00**

**Sunnex** low voltage halogen spot lights are available in 20W, 35W, 50W and 75W of intensity. These lights feature a swivel joint with 360° axial rotation and 90° angular adjustment. While all spot lights are low voltage, an integrated transformer can be provided by special request on certain models.

## HS Series

This safe, low voltage 20W spot light is designed for direct connection. It is ideal for production, inspection, medical and research applications. A remote transformer is also available.

### Features:

- Safe 12V or 24V-20W halogen bulb
- Square, rectangular or panel sub base
- Rocker switch on base
- Optional dimmer (HS761 only)
- Clear lens is standard - frosted, blue, red or UV lens optional



**Model  
HS762-00**

## HS Series Accessories



**Lenses/Filters** include clear, frosted and red lenses; UV and blue filters.



**Bulbs** supplied are 12V/20W halogen. Optional 12V/20W Dichroic Lamps dissipate 60% of heat through back of lamp thus reducing the amount of heat projected forward.

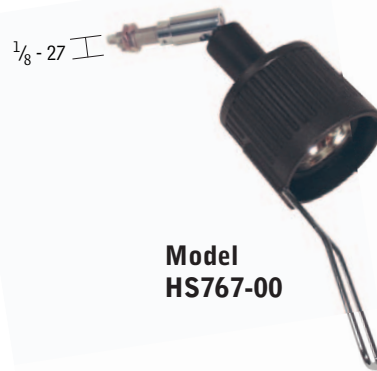

**Model  
HS767-00**



**Switch on Head** (-HS) For convenient on/off control, a push button switch can be mounted on the back of the lamphead.

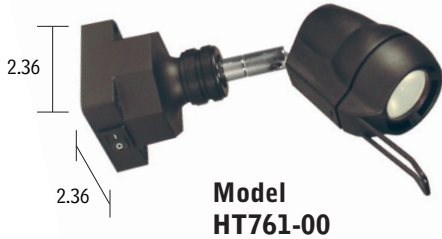

**Model  
HT761-00**

### HT Series

This compact model is a safe, low voltage 20W spot light designed for direct connection. It is ideal for inspection and medical applications. A remote transformer is available.

Features:

- Safe 12V or 24V 20W halogen bulb
- Square sub base
- Rocker switch on base
- Optional dimmer
- Frosted lens standard – clear lens optional

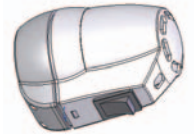

#### Switch on Head

(-HS) For convenient on/off control, a push button switch can be mounted on the back of the lamphead.

### HM Series

This safe, low voltage 35W spot light is designed for direct connection. Just right for medical, research, and inspection applications. A remote transformer is also available.

Features:

- Safe 12V or 24V-20W halogen bulb
- Square, rectangular or panel sub base
- Rocker switch on base
- Optional dimmer (HM1141 only)
- Frosted lens is standard – clear lens optional



**Model  
HM1141-00**

**Switch on Head** (-HS) For convenient on/off control, a push button switch can be mounted on the back of the lamphead.

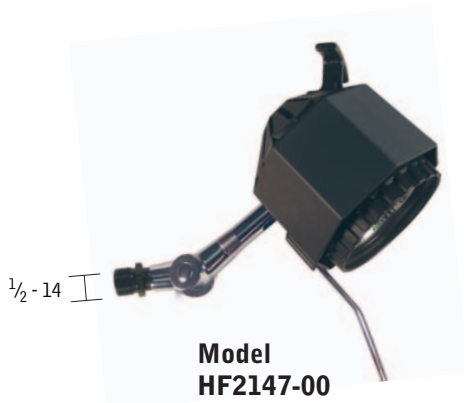
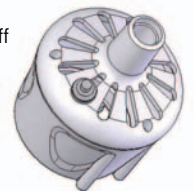

**Model  
HF2147-00**

### HF Series

A safe, low voltage 50W/75W spot light designed for direct connection. Perfect for production equipment, assembly workstations, and other machinery. A remote transformer is available.

Features:

- Safe 12V or 24V-20W halogen bulb
- Square or panel sub base
- Rocker switch on base
- Optional dimmer (HF2141 only)
- Clear lens is standard – frosted lens optional

### HT, HM & HF Lenses

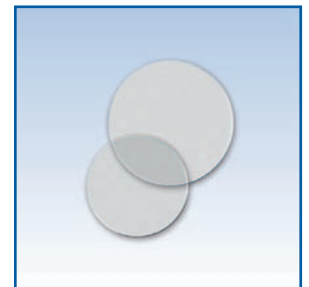

**Lenses/Filters** includes clear or frosted lenses.

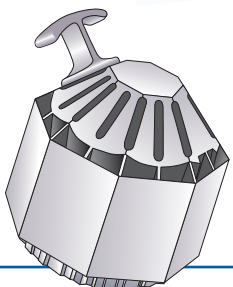

**Ventilation** Vented casing allows heat to dissipate through the back of the lamphead.

The CL Series offers low heat emission and bright, fluorescent light. It is available in a flexible gooseneck for easy positioning. The CL series comes standard with a 9W compact fluorescent bulb.

Features include:

- Energy efficient 9W fluorescent light source
- Specially designed lamp head helps prevent glare and minimizes eyestrain
- Flexible gooseneck allows easy positioning
- Low heat emission

**CL Series Lux Table**

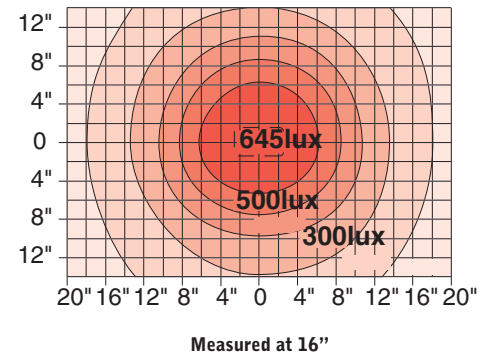

**CL3000 - Flexible Gooseneck Light**

|                      | Standard              | Optional                            |
|----------------------|-----------------------|-------------------------------------|
| Power supply         | 120V                  | 230V (Euro plug)                    |
| Arm Length           | 20"                   | -                                   |
| Lamp Head            | Straight neck         | -                                   |
| Base                 | Direct                | Magnetic, C-Clamp, Table, L-Bracket |
| Switch               | Rocker switch on base | -                                   |
| Dimmer               | No                    | No                                  |
| Cord                 | 7' SJT                | -                                   |
| Safety Class (Int'l) | IP20                  | -                                   |
| Color                | Matte black           | Off-white                           |

Ideal for applications including:

- Assembly Areas
- Office and Computer Workstations
- Workbenches
- Laboratories

**CL Series Mounting Options**



**Sunnex** has been designing and manufacturing lighting for over three decades therefore we can customize lighting for almost any application. Many leading manufacturers rely on **Sunnex** because of our expertise in this area.

If you do not see a product that meets your exact requirements please contact us directly and our engineers will work with you to create a custom lighting solution that fits your specific needs. Below are some examples of our custom lighting solutions.

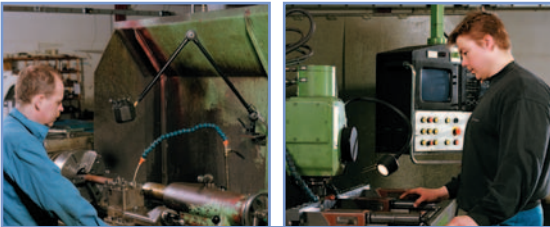

**Industrial Lighting**

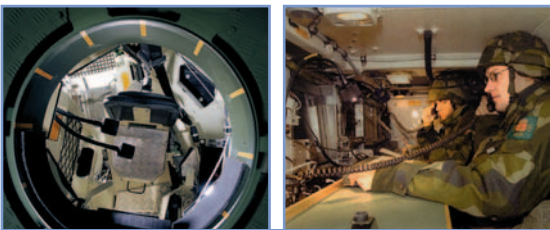

**Military Lighting**

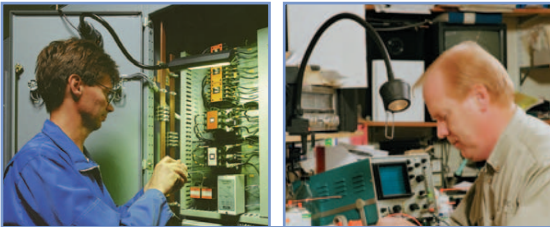

**Electronic Lighting**



**Marine Lighting**



**Medical Lighting**



What  
lighting  
solution  
can we  
provide for  
you

**Contact Sunnex for your custom lighting needs**

## Sunnex Worldwide

Sunnex sales and service representatives are located in over 40 countries worldwide, with the American headquarters in Natick, MA, and its European headquarters in Stockholm, Sweden. Sunnex is an ISO 9001:2000 registered company.

In addition to its complete line of lighting, Sunnex also manufactures an extensive line of anti-vibration and leveling products. These products are ideal for various industries including injection molding, packaging, metalworking, and electronic equipment. For more information, please visit our global web site at [www.sunnex.com](http://www.sunnex.com).



Visit our USA web site at [www.sunnexonline.com](http://www.sunnexonline.com)



### Sunnex Inc.

3 Huron Drive  
Natick, MA 01760-1314  
USA

Toll Free 800 445 7869

Tel 508 651 0009

Fax 508 651 0099

E-mail [sunnex@sunnex.com](mailto:sunnex@sunnex.com)

[www.sunnexonline.com](http://www.sunnexonline.com)

### Sunnex Equipment AB

Box 8064  
SE 163 08 Spånga  
Sweden

Tel +46 8 546 802 30

Fax +46 8 546 802 59

E-mail [info@sunnex.se](mailto:info@sunnex.se)

[www.sunnex.com](http://www.sunnex.com)

### Sunnex GmbH

Ricarda-Huch-Str. 2  
D-14480 Potsdam  
Germany

Tel +49 331 600 77 27

Fax +49 331 600 77 63

E-mail [h.wickstrom@t-online.de](mailto:h.wickstrom@t-online.de)

[www.sunnex.com](http://www.sunnex.com)

### Sunnex Equipment Sarl

Z 1 les Milles BP 15400  
13794 AIX Cedex 3  
France

Tel +33 442 397 896

Fax +33 442 397 877

E-mail [sunnex@sunnex.fr](mailto:sunnex@sunnex.fr)

[www.sunnex.fr](http://www.sunnex.fr)